

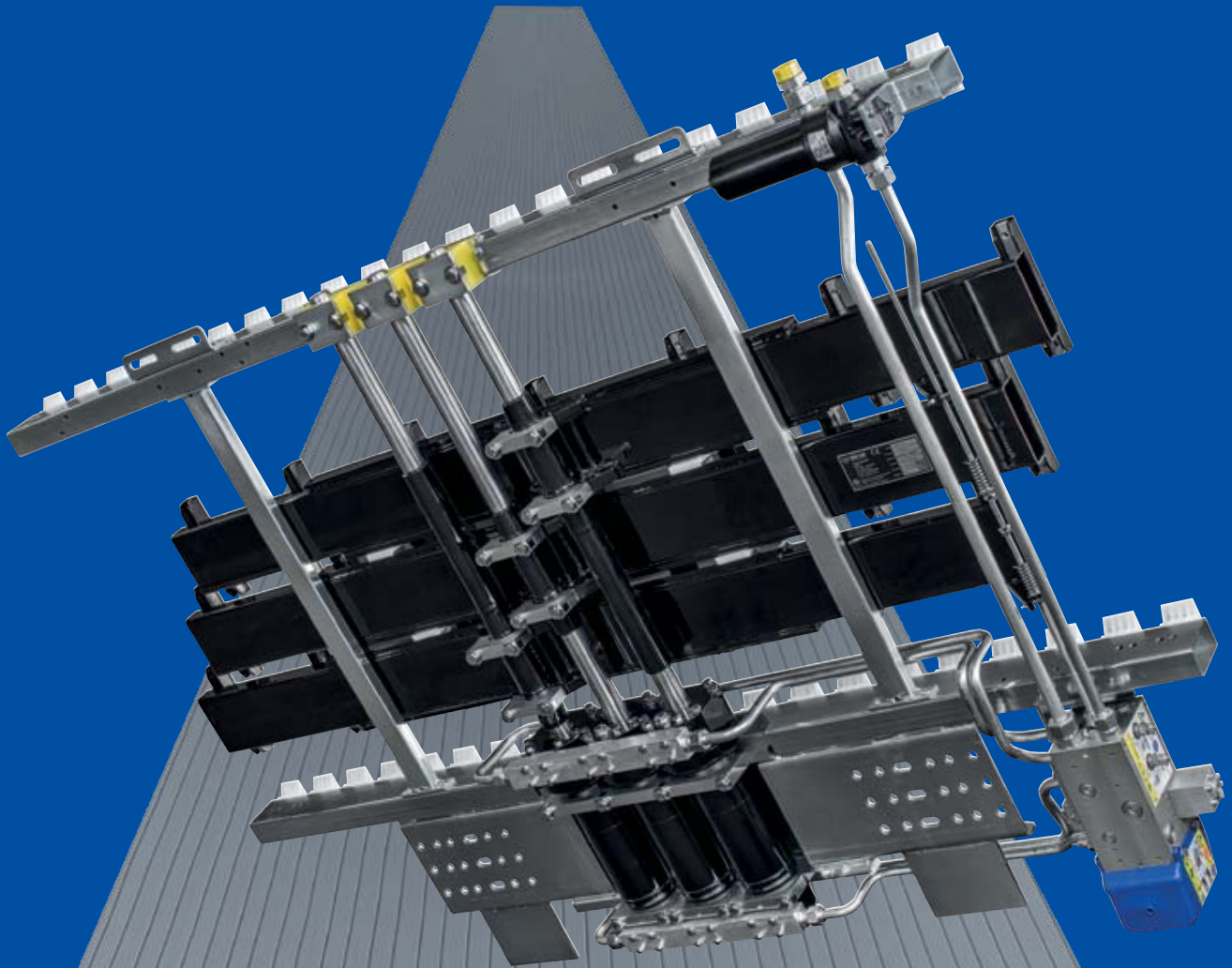

CARGO FLOOR[®]

HORIZONTAL LOADING-/UNLOADINGSYSTEM





COMPANY PROFILE

Cargo Floor B.V. is the worldwide leading manufacturer and supplier of horizontal loading and unloading systems which are exported all over the world. With more than 30 years experience, excellent quality and an extremely high level of service, Cargo Floor B.V. is now recognised in the entire industry as the **world wide renowned market leader!** . Cargo Floor B.V. manufactures its products in Coevorden, The Netherlands, under the **ISO 9001-2008** quality label (certified by Lloyds). Before delivery, each system is tested extensively for proper functioning, geometry and sealing. This ensures that every Cargo Floor® 'moving floor®' System is easy to install and functions excellently anywhere in the world.

Cargo Floor B.V. has specialised in the following product groups:

- Cargo Floor® mobile systems for the truck and trailer industry
- Cargo Floor® stationary systems for self-unloading transport/dosing systems in factories (design, advice and implementation)
- CargoMatic® "The Logistic Solution", a dock-to-trailer system for fully automatically loading and unloading packed materials within 90 seconds
- Service and installation
- Trailer rental

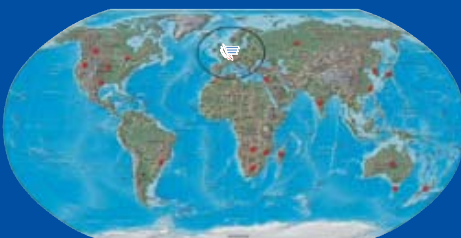

THE ULTIMATE MOVING FLOOR®

Cargo Floor B.V. is the worldwide leading manufacturer and supplier of a unique multifunctional horizontal loading and unloading system for fast and efficient transport. The Cargo Floor® system is based on a moving floor® principle, this means that the transport of the goods you want to unload or load from your trailer is actually done by the movement of the floor. The variation in friction between the floor and the product makes it possible to load and unload a wide variety of bulk materials and other goods; like pallets, bales and paper reels!

The enormous success of Cargo Floor's hydraulic operated drive units is based on a simple and easy to install system, suitable for all types of trailers and equipment. Besides the ultimate standard Cargo Floor® system (CF500) which can virtually transport all products there are also dedicated Cargo Floor® drive units and flooring available for special applications.

Development

In close collaboration with OEM's engineers, extensive field experience (>30 years) and practical feedback from the market (transport companies), material handling experts, logistic managers, Cargo Floor® has developed the most reliable, strongest and still the lightest moving floor® system in the world.

By using the very latest engineering technology and state of the art components Cargo Floor® is known as the most innovative manufacturer and supplier of moving floor® systems in the world.

The Cargo Floor® drive units are powered by hydraulics – the necessary sequence is done mechanically by internal valves which result that atmospheric conditions and dirt have absolutely no influence on the system's operation and performance. It is obvious that a number of factors are of fundamental importance to achieve a fast return on your capital investment. The Cargo Floor® systems fulfill all the important factors, such as maximum cargo volume, lowest tare weight of your vehicle, low operational cost (maintenance free), durability, human safety and environmentally friendliness, sustainability and longlasting.

The latest Cargo Floor® drive units meets all these requirements.



HORIZONTAL LOADING-/UNLOADINGSYSTEM



Highest quality Dutch and German made Heavy Duty cylinders



Double chromated solid piston rods



High pressure filter is standard



All valves/cylinders are protected against road dirt



Passivated hydraulic piping



The drive units are standard preserved against rust by the best Cathodic Dip Painting (CDP) process



The control valve is positioned at the outside of the trailer for easy access



Common-rail technology

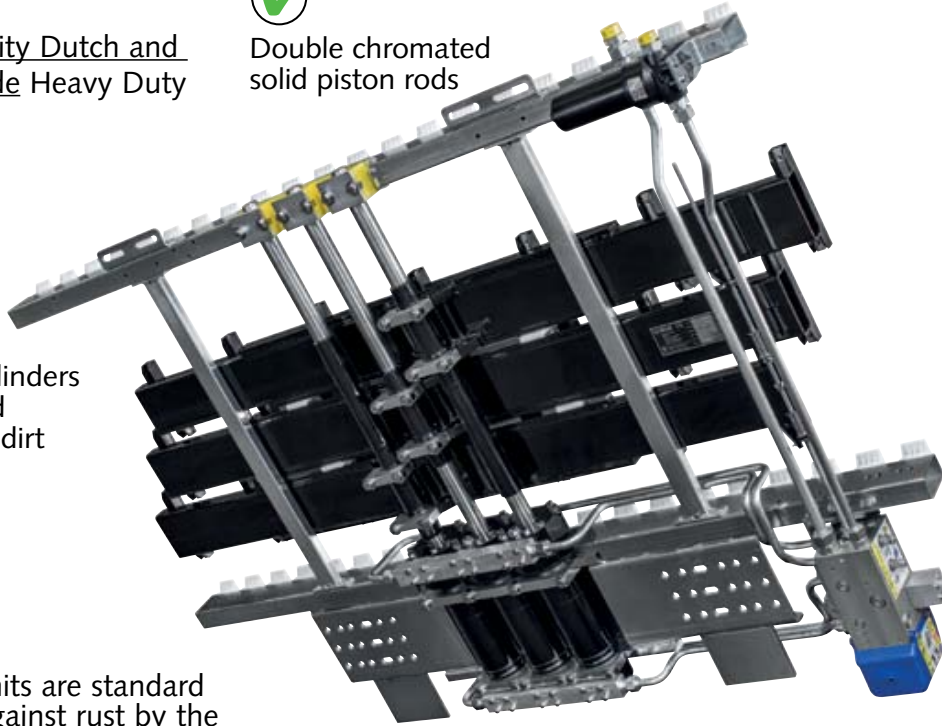

Sustainable environmental conservation: Because Cargo Floor is the only company in the world that fully preserves its drive units with a CDP finish, the system does not need to be repainted or refinished during its lifetime.



HOW IT WORKS

The Cargo Floor 'moving floor'® System is a multi-functional, horizontal loading and unloading system for the fast and efficient transport of almost any product. The system is ideal for unloading a wide variety of bulk products, which typically are loaded from above and unloaded horizontally from the rear by the Cargo Floor 'moving floor'® System. It can also be used to load and unload packed materials.

Floor structure

The Cargo Floor 'moving floor'® System is composed of floor profiles installed lengthwise, parallel to each other. The Cargo Floor drive system moves the floor profiles back and forth within the power stroke of the three hydraulic cylinders. The cylinders are driven by mechanical or hydraulic systems (no electronics). The floor profiles are made primarily from aluminium, but they can also be supplied in steel or another material.

The density between the floor profiles is ensured by a high-quality plastic sealing profile; Semi Leak Proof floors and even 100% Leak Proof solutions are available.

Clean unloading of bulk products

By using a moving partition, the floor/container can be unloaded in a virtually clean manner. The moving partition hangs from running rollers that are mounted on an integrated rail at the top of the side wall (Cargo Floor has developed special heavy-duty six-wheel rollers for this purpose, which also clean the rail in two directions; Art. no. 5165003). A cloth, onto which the cargo is unloaded, is secured underneath the moving partition for moving the partition across the floor. But a cloth over the floor, instead of a moving partition, will do just as well. Do not forget to roll it back manually (for the sake of reliability, weight, costs) and hang it on the bulkhead for the next cargo.

Returning packed cargo

Besides bulk cargo, you can also load and unload a variety of packed cargo, such as: pallets, paper rolls, big bags, compressed bales, etc.

The Cargo Floor moving floor® principle:

Step 1: three hydraulic cylinders move the entire floor as a whole in the selected direction, thereby transporting the cargo

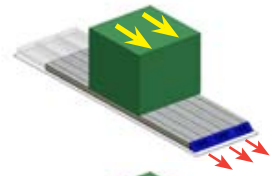

Step 2: one hydraulic cylinder pushes one group of floor profiles (= 1/3 floor section) back underneath the cargo, while 2/3 of the floor section remains still, the cargo will hardly move as a result

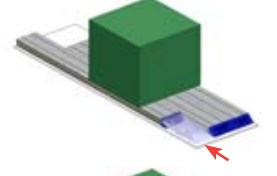

Step 3: one hydraulic cylinder pushes one group of floor profiles (= 1/3 floor section) underneath the cargo, while 2/3 of the floor section remains still, the cargo will hardly move as a result

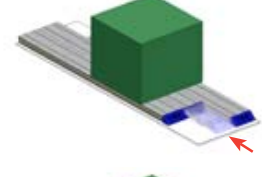

Step 4: one hydraulic cylinder pushes the third and last group of floor profiles (= 1/3 floor section) underneath the cargo, while 2/3 of the floor section remains still, the cargo will hardly move as a result

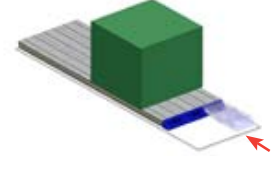

Step 1 is repeated again. The frequency and thus the speed at which these steps are repeated depend on the output of the hydraulic pump. The available power at which the cargo can be moved depends on the available pressure of the hydraulic pump. The Cargo Floor 'moving floor'® System is designed for a maximum payload of 44 us tons / 40 tons.

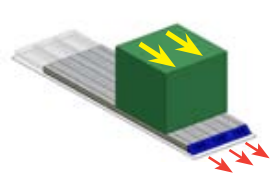

The principle works in two directions, in other words the Cargo Floor 'moving floor'® System can be used to LOAD and UNLOAD product.

Transportation speed (theoretical):

Standard 2,6 m/min. = unloading trailer 13.6 mtr. appr. 6-10 min.
Powerspeed 4,8 m/min. = unloading trailer 13.6 mtr. appr. 3-5 min.



MODULAR OPERATING POSSIBILITIES

STANDARD



OPTIONAL



Thanks to its modular construction, the following operative versions of the Cargo Floor 'moving floor'® System are possible (also retrofittable):

- E-control** with loading / stop / unloading over a switch
As a standard provided with a manual override by means of a unique red "Cargo" rotary switch
(Optional: radio remote control)
- B-control** with loading / stop / unloading over a manual handle, with unique "S" detent mechanism in order to determine loading / stop / unloading position. on / off switching over a switch
As a standard provided with a manual override by means of a unique red "Cargo" rotary switch
(Optional: radio remote control)
- A-control** with loading / stop / unloading over a manual handle, with unique "S" detent mechanism in order to determine loading / stop / unloading position. (non-electrical)



E
control

Manual override by means of a unique red "Cargo" rotary switch.



B
control



A
control

↑ Unique "S" detent mechanism in order to determine loading/stop/unloading position.



THE CARGO FLOOR TRAILER

Floor mouting

Normally done by sliding in the floorprofiles. Alternatively it can be done from above without the need of sliding. This can be useful in case of limited installation areas.

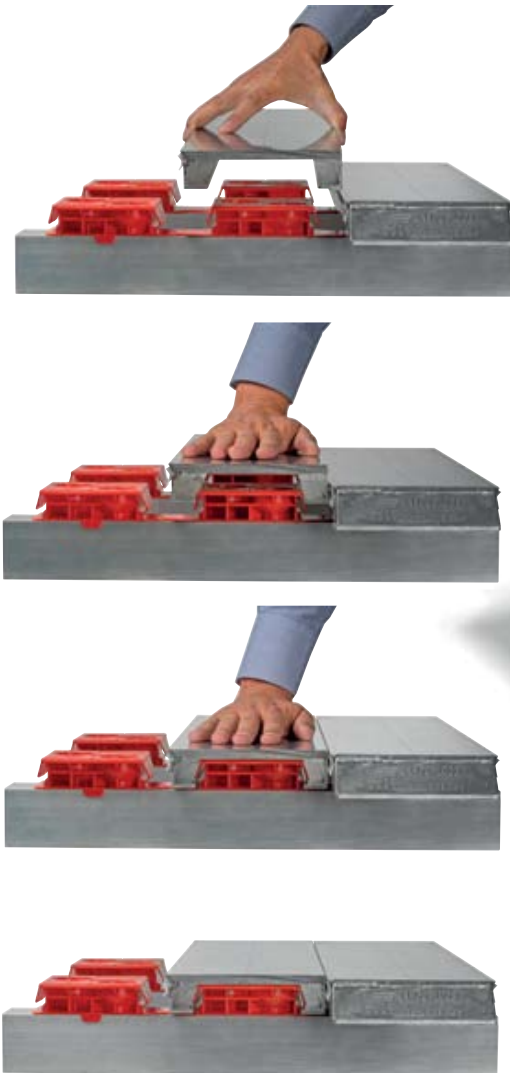

Endcaps safe + clean

The Cargo Floor system is supplied with endcaps angled 45 degrees to seal the ends of the aluminium floor profiles with the result that your vehicle is securely sealed on the rear side and no jamming can occur.

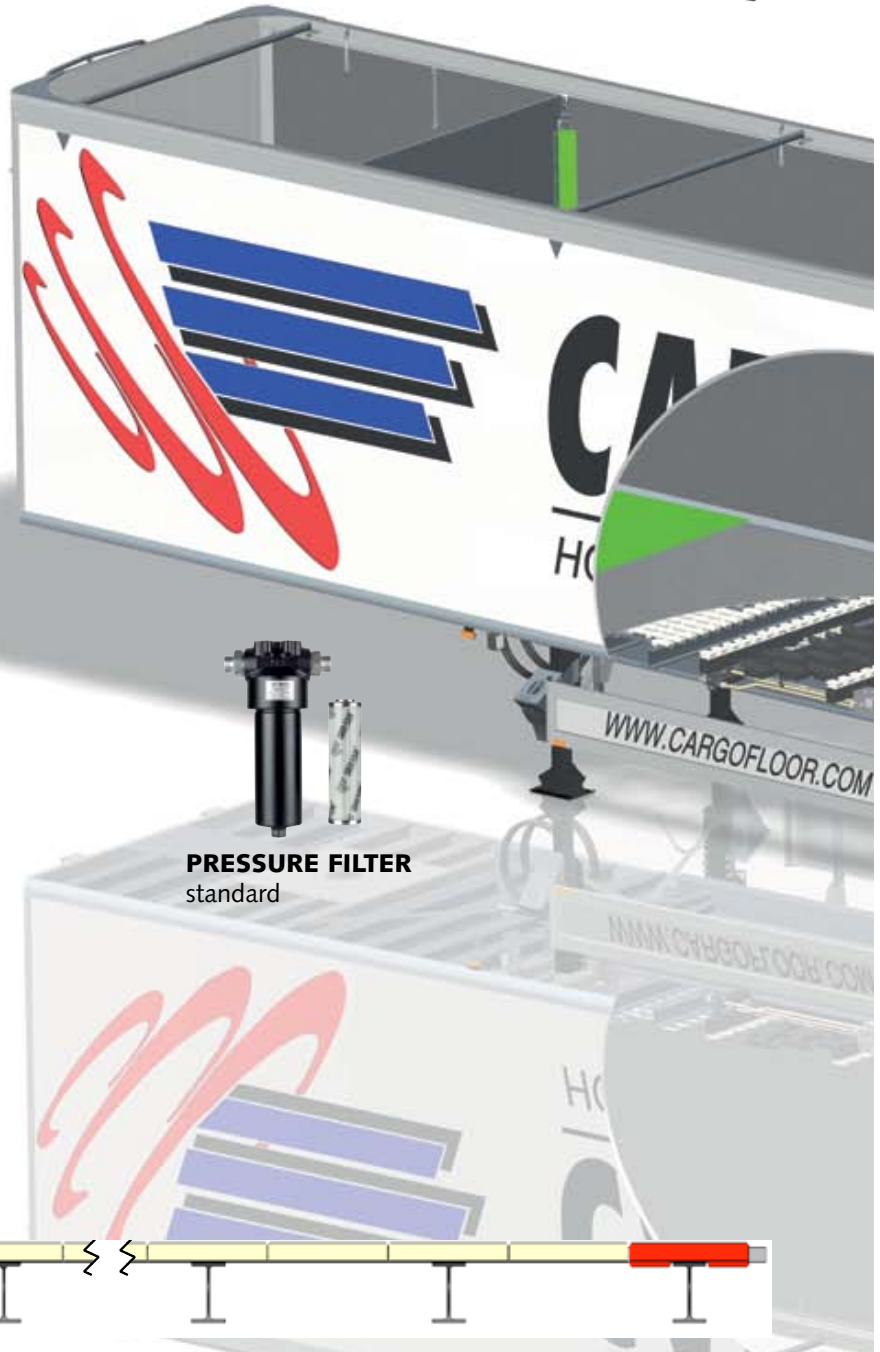

PRESSURE FILTER
standard

CARGO 'SNAP-ON' BEARING BLOCK

With this patented Cargo snap-on bearing block you can easily make a full length support and guidance and with the special integrated **Anti-Splash lip**, road dirt cannot enter or effect the subdeck and floor profiles.

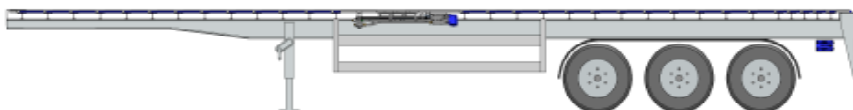
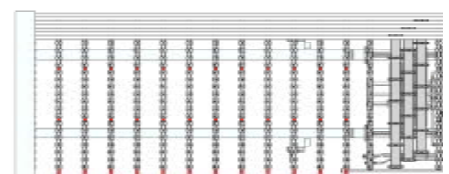
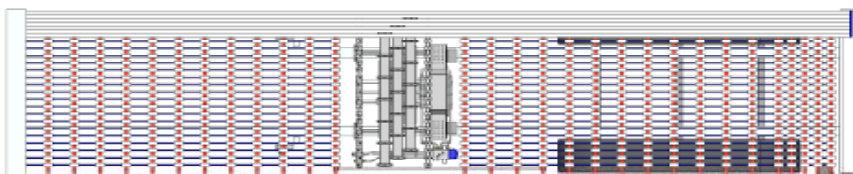

The seal between the floor profiles is of a unique plastic composite (Nobraforte) that will usually outlast the aluminum. The seal has been designed to ensure that the load cannot leak through the floor and blocks road dirt and splash water from entering into the trailer.

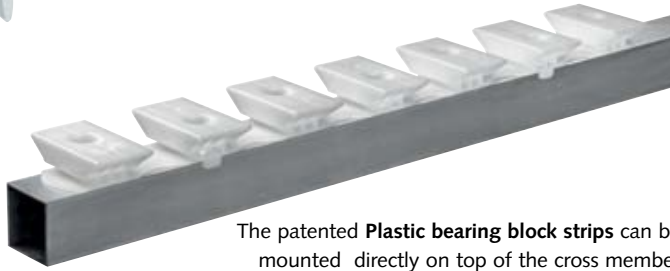

The patented **Plastic bearing block strips** can be mounted directly on top of the cross member and can be secured by screws or pop-rivets. No subdeck required!

The patented **TWISTER** can be fitted easily and rapidly to the 25x25mm [1x1"] subdeck "tube-" or "U-" profile (supplied by the trailer builder); no tools are required.

By virtue of its **ingenious construction** the full weight on the aluminium floorprofile is support by the thickest internal surface of the floorprofile. Road dirt does not exert an influence on the useful life of the aluminium – and, moreover, the design provides for the maximum stability when subjected to heavy loads (largest sliding surface 8700mm² [13.5 sq"] each).

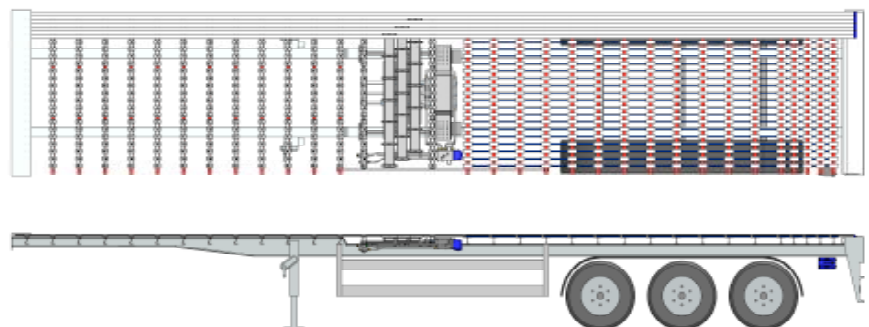
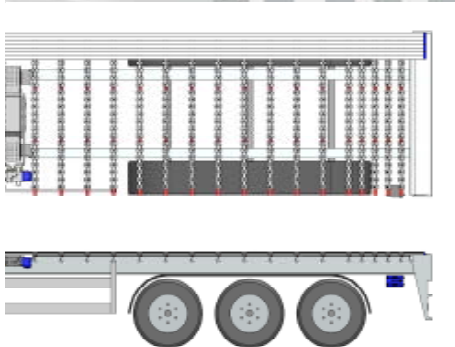
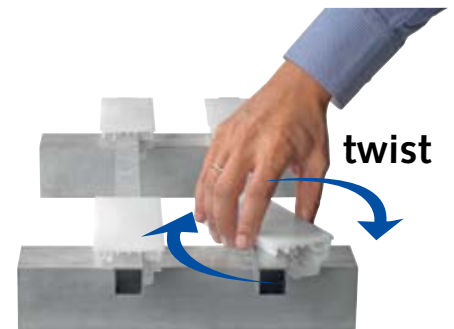
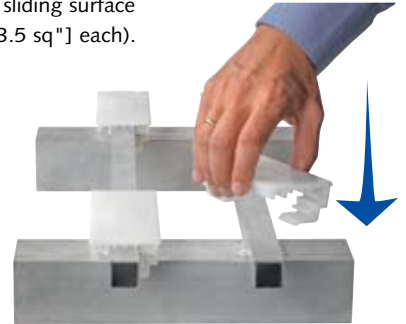

Cargo Bulkmover = 15 Moving Floor profiles

The Bulkmover is the smart solution for transport of bulk products.

Mainly for loose product

Because the floor profiles of the Cargo Bulkmover are wider than the standard 21 floor profile execution this concept is not suitable for the loading and unloading of pallets and paper reels with the help of the floor movement of the Cargo Floor system. Off course pallets eg. can be loaded - and unloaded - by driving a hand pallet truck or fork lift truck over the floor.

More than 20 years of experience with the wide floor profiles, mainly in stationary factory applications, has proven that the 15 floor profile version of the Cargo Floor system is extremely suitable for the efficient unloading of most common loose products in large volumes.



Weight reduction

In order to reduce weight in a safe and reliable way Cargo Floor has developed an alternative floor: an execution which has 15 floor profiles instead of the usual 21. The total moving floor surface is exactly equal to the the 21 moving floor profiles, because of which no adjustment of the side profile is needed.

Characteristics of the 15 floor profile Cargo Bulkmove concept:

- Weight advantage for the complete trailer; depending on the execution at least 60 kg. and can go up to 300 kg.
- 30% less seams between the floor profiles; possible leakage and wear substantially decreases;
- 30% less seal between the floor profiles. Also the seal is very well protected from the product transported;
- 30% less mounting time for the sub floor construction, floor profiles and bearing;
- Increased stability of the floor profiles because of the "Cargo Twister Wide 40/25" bearing with very wide bearing surface and support on three spots;
- Very large bearing surface, because of which less wear;
- Less wear;
- Larger bearing and sliding surface of the "Cargo Twister Wide 40/25" (+7%);
- Bearing does not come into contact with the transported product (no extra wear) and is protected against spattering street dirt by the floor profile;
- Floor width is identical to the standard 21 floor profile execution; no need to adjust the side profile;
- All hydraulic components: cylinders, valves, are identical to the CF500 SL-C 21 floor profile system;
- Suitable for the Power Speed execution: unloading in +/- 3 min. (ask about the requirements);
- Various floor profiles available, among which a special HD and ultimate XHDI version for the transport of all kinds of waste: glass, sand eg.
- Very clean discharge
- Suitable for all types of Cargo Floor drive units;
- Extreme long durability;
- Robust and very stable;
- No maintenance required;
- Absolutely lower cost of ownership
- 30% less work if a floor revision needs to be done and turning the floor is a lot easier;
- Pallets, paper reels eg: only loading / unloading with the help of a fork lift truck or pallet wagon.

Fork-lift truck

In principle all Cargo Floor floors can be driven on by a fork-lift truck; contact your body builder for information about the permitted weights!



LR-serie 'Leak Resist'

Because Cargo Floor is committed to leaving as small an environmental footprint as possible (leakage of products on the road is quickly considered an environmental crime), liquid-containing "waste" products must be transported in a safe and environmentally sound manner.

Cargo Floor has over 20 years of experience with its unique 100% watertight system solutions where a Cargo Floor drive system is mounted in the front of the trailer.

To make the Leak Proof concept easier and more accessible to a larger target group, Cargo Floor has developed a unique and special subdeck principle whereby the standard Cargo Floor undermount drive unit can as usual be mounted UNDER the floor. Tested for years, this special watertight subdeck concept has proven to be the ultimate solution in preventing leakage of liquid-containing products on the road.

Unlike the 100% Leak Proof system, the bodybuilder does not need to make any modifications to the vehicle for mounting the Cargo Leak Resist application. Besides a weight advantage, it also delivers a high volume advantage, as the inclined sealing bulkhead wall is not required in this application.

With the supply of the unique Cargo Leak Proof Subdeck, a regular sub-floor will not be required anymore. The simple 'slide-in' system of the subdeck profiles makes installation fast and easy in both new and retrofit applications.

A solid bearing block is installed across the entire length of the floor under the moving floor profiles. What makes this unique is the fact that ABSOLUTELY NO end sealing section is used with this Leak Proof flooring solution. Also, the product will not come into contact with the solid under-floor bearing block during transport. There are currently two deckslat versions (moving floor profiles), the standard 7mm aluminium and the 10 mm heavy-duty aluminium model. Alternatively, you can also obtain for the STEEL profiles.

The space between the moving floor profiles is largely self-cleaning, but thanks to its open shape, it can be easily and efficiently cleaned with a broom or pressure washer.

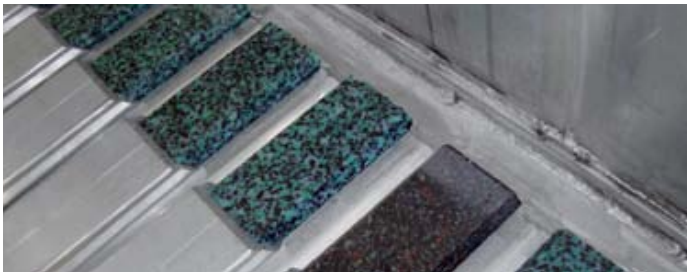

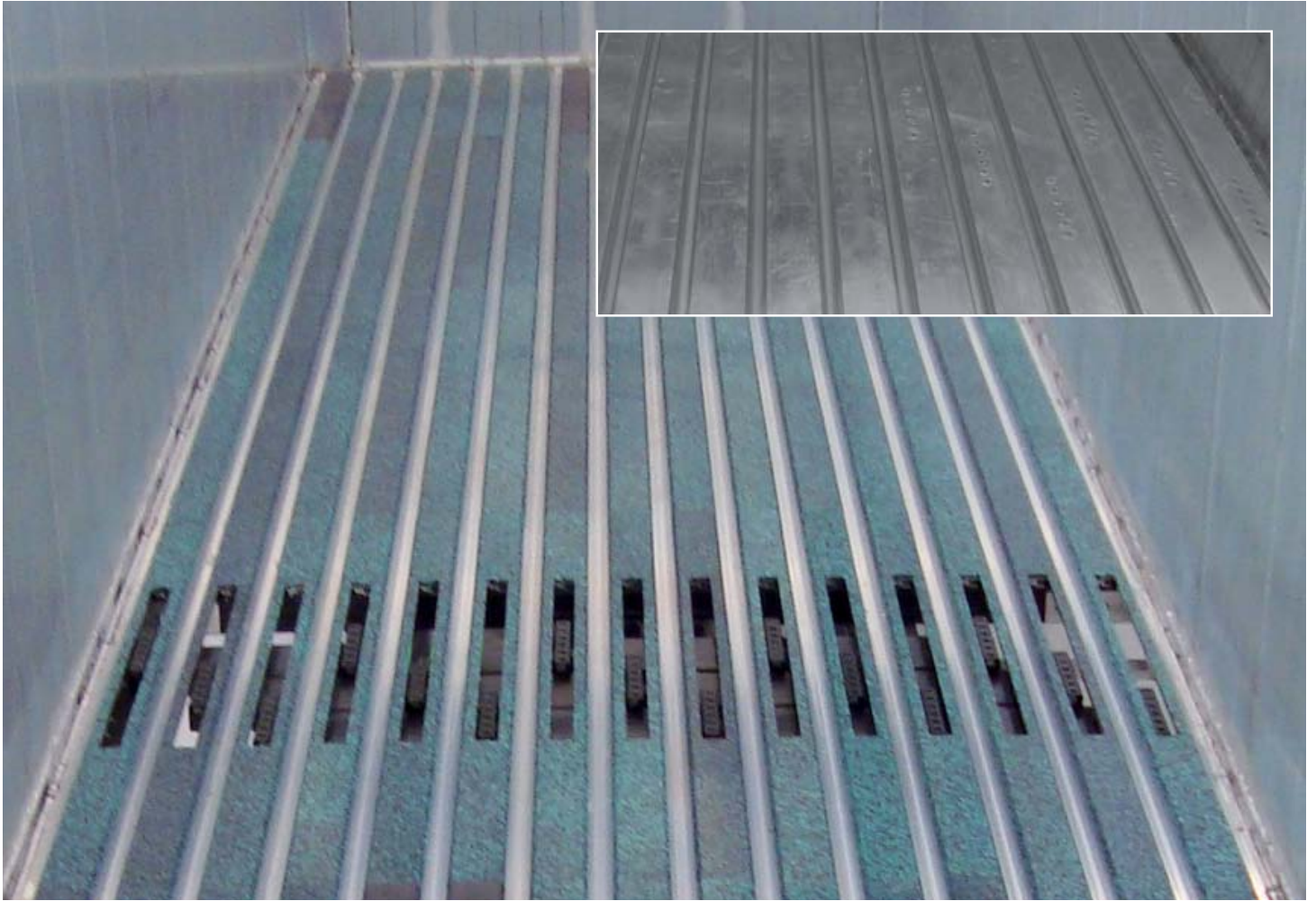

THE CARGO FLOOR LEAK RESIST WITH UNDERMOUNT DRIVE UNIT IS THE ULTIMATE SOLUTION FOR PROTECTING THE ENVIRONMENT FROM LIQUID-CONTAINING "WASTE" PRODUCTS DURING TRANSPORT. ALL STANDARD CARGO FLOOR DRIVE UNITS CAN BE APPLIED.



Important remark!

The LR-serie = leak resist and is NOT granted to be 100% Leak proof because of the undermount drive unit construction. Any leakage that may occur will only be possible and centrated at the connection area between the drive system and the floor profiles. A collector bin could avoid any spilling on the floor.

LP-serie 'Leak Proof'



A compact waterproof system

This **100% leak proof Cargo Floor-system** has been developed for transporting environment-polluting products, both in the form of loose bulk material as well as compressed bales. The system is excellently suited for transporting and storing **DOMESTIC WASTE** and vegetation waste.

To achieve a 100% leak proof moving floor in your trailer you need to use a so called Front Mount Drive Cargo Floor system type CF3LP. Thanks to the unique and compact design and the use of space in the so-called head radius, which minimises the loss of loading space. The inclined sealed partition also protects the drive system.

The aluminium sub-floor is easy to fit on both steel and aluminium chassis-frames, and is readily secured either by screws or rivets to the sub-floor members outside of the waterproof section.

Virtually no welding is required, since the sub-floor sections are simply slid into each other and becomes 100% waterproof with silicone sealant.



The aluminium floor sections are guided along their entire length, and are supported by solid plastic bearing blocks. Either standard aluminium section or HDI (Heavy Duty Impact) sections are available. The latter system is ideally suited to situations in which high impact forces are imposed on the floor.



APPLICATIONS

The standard Cargo Floor 'moving floor'® System is ideally suited to the transport of almost all common products. In addition to the standard system, Cargo Floor also has a range of different drive units and floor sections available for special applications. The range of sections encompasses narrow or broad and ribbed or smooth sections in a variety of thicknesses. Sections are also available in a variety of materials (aluminium/steel/composite/plastic, or a combination of these materials).

Cargo Floor has proven its quality in the transport

- bulk materials
- wood chippings
- sawdust
- bark
- logs of wood
- potting soil
- peat
- clay
- bleaching earth
- straw
- straw bales
- maize
- grain
- potatoes
- carrots
- tapioca
- milk powder
- coffee beans
- soya beans
- alfalfa
- sugar beet and pulp
- chicken feed
- manure
- fertilizer
- salt
- chalk
- coal
- used paper
- rolls of paper
- aluminium scrap
- domestic waste
- cargo (bales / bags)
- big bags
- pallets
- Slaughter waste
- Sewage sludge
- Compressed bales
- etc.

When used in combination with the special automatic roll-up protection sheet (see pictures) the Cargo Floor can also be used for the trouble-free transport of the following products:

- glass
- gravel
- ore
- sharp sand
- vegetables and fruit
- all other abrasive materials

Fork-lift truck

In principle all Cargo Floor floors can be driven on by a fork-lift truck; contact your body builder for information about the permitted weights!

Efficiency/output

Efficiency of loading and unloading (packed) cargo is determined mainly by the flatness and the even weight distribution of the cargo over the floor area of the Cargo Floor. Uneven weight distribution will reduce efficiency and may even cause the cargo to only move back and forth within the power stroke of the system. Uneven cargo weight distribution can be compensated by using supports to spread the weight evenly across the floor profiles. The system's operating speed can also affect loading and unloading efficiency.



CF100 'Ultra Light'

This unique light-weight Cargo Floor-system has been developed especially for simple installation in trucks, drawbar trailers, containers and interchangeable containers (demountables).

A few characteristic of the CF100 system:

- Lowest installation height possible in combination with 80 mm. cross member
- Extremely low intrinsic weight of the power unit
- Floor speeds between 0 – 2.5 metres / min.
- The entire hydraulic drive is controlled solely by mechanical/hydraulic means
- The pre-assembly of the cylinders, pipes and valves in a compact frame ensures a very simple and rapid installation
- Floor construction identical to the standard Cargo Floor-system
- Sub-frame may be dropped, in which case the hydraulic drive can be integrated in your own structure (for example aluminium/composite)
- Enables the maximum cargo volume to be utilized
- Suited for use as an autonomous metering silo
- Maximum load 20 tonnes
- Maximum floorlength 9,000 mm
- Passivated hydraulic piping

Thermally zinced subframe (optional)
CDP is standard



CDP preserved moving cross members (standard)

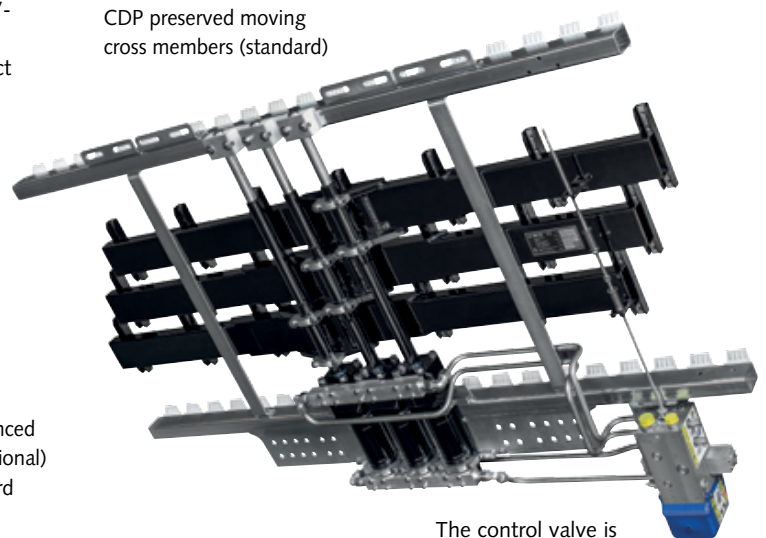

The control valve is standard positioned outside the chassis, because of that it is simply accessible



Cargo 'Snap-on' bearing block

The Cargo is a one-piece 'Snap-on' bearing block with anti-splash lip.

This newly developed Cargo 'Snap-on' plastic bearing block is a unique design with which a solid one-piece full length bearing strip can be created.

Injection moulding rather than extrusion was chosen for this process, as it achieves the high density and precise dimensional stability required. Despite the large surface of the one-piece Cargo 'Snap-on' bearing block, it exhibits extremely low friction and the very high wear resistance one has come to expect of the Cargo Floor bearing block.

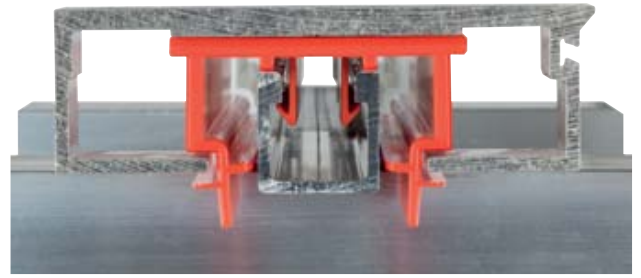

Anti-Lifting/Hold-Down Block:

The unique hooks clamped into the support rail prevent the bearing block from vertically protruding from the rail, thereby holding the floor profiles in place at all times.

Anti-Splash lips:

The Anti-Splash Lip prevents road splash and debris from entering the support rail and contaminating the inside of the floor profiles, keeping wear to the bottom to a minimum.

Aluminum subdeck:

The special 25x25 [1x1"] aluminum U-shaped square section not only provides stability between the cross beams, it also serves as support and anti-lifting device for the plastic Cargo 'Snap-on' bearing block. This profile can also be used for other bearing blocks, such as the Cargo Twister.

This aluminum U-shaped profile can also be riveted on steel cross members.

Simple and ergonomically assembly:

- Press the Cargo 'Snap-on' bearing blocks vertically from above into the aluminium support rail.
- Slide the Cargo 'Snap-on' bearing blocks in the aluminium support rail (press a vertical stopper at each end of the rail to lock the bearing blocks in place)



Profile survey standard Cargo Floor system

Profile type

Clarification

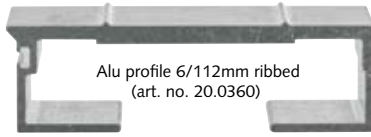

Alu profile 6/112mm ribbed
(art. no. 20.0360)

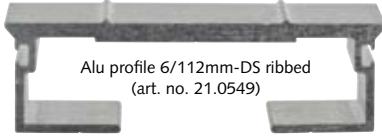

Alu profile 6/112mm-DS ribbed
(art. no. 21.0549)



Alu profile 6/112mm smooth
(art. no. 22.0547)

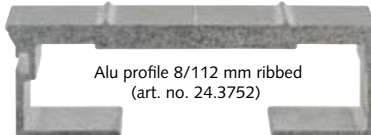

Alu profile 8/112 mm ribbed
(art. no. 24.3752)



Alu profile 8/112 mm smooth
(art. no. 37.1505)



Alu profile 10/112 mm ribbed
(art. no. 25.0550)



Alu profile 10/112 mm smooth
(art. no. 27.0552)

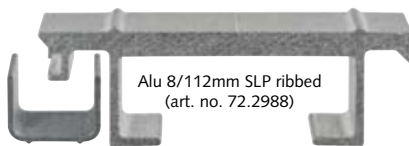

Alu 8/112mm SLP ribbed
(art. no. 72.2988)

(possible with SLP-channel (art. no. 755.4525))



Alu profile 8-20/112 mm HD
(art. no. 31.1197)

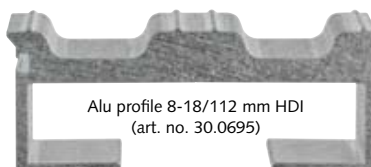

Alu profile 8-18/112 mm HDI
(art. no. 30.0695)

The ultimate standard.

The balanced weight and strong proportions makes this profile suitable for almost every product that needs to be transported. The ribs are only meant to provide traction and guidance to the product (mainly to avoid twisting of pallets). The unique shaped seal can be pulled in the profile to avoid leakage and protect the transported product against road dirt and water splash. The seal itself is also protected by the shape of the profile. To seal both sides of the moving floor surface one double seal profile is provided. With this double seal profile the floor can be easily turned after several years, to extend the life time. This profile can be mounted on most of the plastic bearing blocks and sub decks available.

The plastic bearings underneath are protected by and enclosed within the shape of the aluminum profile, this gives an excellent stability to the floor profile and is also protected against street dirt. The enormously large support and bearing surface provides an extremely long lifespan. For safe and clean emptying the trailer, all floor profiles will be sealed with an end cap in either plastic or aluminum. The profiles are maintenance free, however cleaning with a high pressure steam cleaner is permitted without any concessions. The width of the profiles is engineered so that enough space remains for two fixed side profiles in which approved cargo lashing eyes can be mounted. The profile is 100 % recyclable and keeps a certain residual value.

Completely smooth for product protection

This smooth profile is almost identical with regards to the shape and weight to the 6 mm. standard profile, with the exception that the two top ribs have been omitted. This has been done in order to prevent damages to products. If the floor has been mounted correctly this profile has the same excellent qualities as the 6 mm. standard profile. This profile is very suitable for the transport of paper reels and agricultural products.

The compromise between weight and impact.

This "in between" profile has the same shape and qualities as the 6 mm. standard profile. The only difference is that this profile is 2 mm. thicker. This results in even more stability, better suitable for more intense use whereas the risk of deformation of the profile due to product impact onto the floor or driving over the floor with a fork lift truck is reduced. If one can overlook the weight increase we certainly would advice this profile.

The compromise between weight and impact combined with product protection

This "in between" profile has the same shape and qualities as the 6 mm. smooth profile. The only difference is that this profile is 2 mm. thicker. This results in even more stability, better suitable for more intense use whereas the risk of deformation of the profile due to product impact onto the floor or driving over the floor with a fork lift truck is reduced. If one can overlook the weight increase we certainly would advice this profile.

The heavy duty allrounder

Impact, wear resisting and driving over this profile, nothing is too much for this profile. The profile itself has the same specifications as the 6 mm. standard profile but this profile is 4 mm thicker can be used for the transport of almost any product or machine. Only the extra weight and extra cost of this profile could make you choose another profile.

The heavy duty allrounder with product protection.

Impact, wear resisting and driving over this profile, nothing is too much for this profile. The profile itself has the same specifications as the 6 mm. smooth profile but this profile is 4 mm thicker can be used for the transport of almost any product or machine. Only the extra weight and extra cost of this profile could make you choose another profile.

SLP the Semi Leak Proof profile

This is a profile, as the name already mentions, which is almost leak proof. The profile is just as all round as the 8 and 10 version but as an extra feature: moist products cannot leak through the floor directly. Liquids leak into a special gutter. This gutter can be exchanged and can be simply removed out of the floor for cleaning when necessary. This profile does require a small adjustment to the head board. The profile is very suitable for the transport of fine or moist products that may not leak onto the surface when loading, driving or unloading. However it is never meant as leak proof, for this we recommend the LR-/LP series.

A dedicated Heavy Duty profile

This profile is a so called dedicated profile. This means that the profile is especially designed for the transport of special (mostly extreme) products. Because of the two protruding round merlons this profile has a very high impact resistance and the special round shape makes it easy to clean. Moist and dusty parts flow back into the so called barrel shape, so moist, mud and dust can simply be drained to the outside and almost no leakage through the floor occurs. This also protects the seal. Because of the low weight a perfect payload ratio remains. The profile is less suitable for the transport of pallets and packaged goods.

The extreme dedicated Heavy Duty Impact profile

This profile is a so called dedicate profile. This means this is a profile that has been especially designed for the transport of special (mostly extreme) products. Because of the three protruding round merlons this profile has an unbelievable high impact resistance, that can be compared with construction steel. The round shapes makes it easy to clean. Moist and dusty parts flow back into the so called channels, so moist, mud and dust can simply be drained to the outside and almost no leakage through the floor occurs. This also protects the seal. Because of the low weight a perfect payload ratio remains. The profile is less suitable for the transport of pallets and packaged goods.

Multi-functionality	Leak resistance	cleanability	Pallet-/bales transport	Drive over with a fork lift truck	Impact resistance	Weight approx.
						X
						X + 0 kg
						X + 160 kg
						X + 160 kg
						X + 310 kg
						X + 310 kg
						X + 180 kg
						X + 370 kg
						X + 600 kg

Profile survey Cargo Bulkmove

Profile type

Clarification

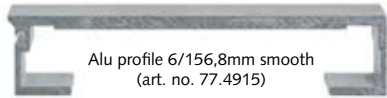

Alu profile 6/156,8mm smooth
(art. no. 77.4915)



Non moving sideprofiles

Completely smooth for product protection extreme light weight

This smooth profile has a balanced weight and strong proportion to make it suitable for transporting almost every product. The unique shaped seal can be pulled in the profile to avoid leakage and protect the transported product against road dirt and water splash. The seal itself is also protected by the shape of the profile. To seal both sides of the moving floor surface one double seal profile is provided. With this double seal profile the floor can be easily turned after several years, to extend the life time. This profile can be mounted on most of the plastic bearing blocks and sub decks available.

The plastic bearings underneath are protected by and enclosed within the shape of the aluminum profile, this gives an excellent stability to the floor profile and is also protected against street dirt. The enormously large support and bearing surface provides an extremely long lifespan. For safe and clean emptying the trailer, all floor profiles will be sealed with an end cap in aluminum. The profiles are maintenance free, however cleaning with a high pressure steam cleaner is permitted without any concessions. The width of the profiles is engineered so that enough space remains for two fixed side profiles in which approved cargo lashing eyes can be mounted. The profile is 100 % recyclable and keeps a certain residual value. Also available in 10 mm. The profile is NOT suitable for the transport of pallets and packaged goods by the movement of the floor.

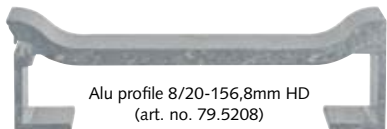

Alu profile 8/20-156,8mm HD
(art. no. 79.5208)

A dedicated Heavy Duty profile

This profile is a so called dedicated profile. This means that the profile is especially designed for the transport of special (mostly extreme) products. Because of the two protruding round merlons this profile has a very high impact resistance and the special round shape makes it easy to clean. Moist and dusty parts flow back into the so called barrel shape, so moist, mud and dust can simply be drained to the outside and almost no leakage through the floor occurs. This also protects the seal. Because of the low weight a perfect pay load ratio remains. The profile is NOT suitable for the transport of pallets and packaged goods by the movement of the floor.



Alu profile 10/22-156,8mm XHDI
(art. no. 81.5440)

XHDI (X-treme Heavy Duty Impact)

This profile is a so called dedicate profile. This means this is a profile that has been especially designed for the transport of special (mostly extreme) products. Because of the three protruding round merlons this profile has a very high impact resistance and the special round shape makes it easy to clean. Moist and dusty parts flow back into the so called barrel shape gutters, so moist, mud and dust can simply drain to the outside and will hardly leak through the floor. This also protects the seal extra. Because of the low weight a perfect pay load ratio remains. This profile is less suitable for the transport of pallets and packaged goods, these need to be loaded and unloaded with the help of a fork lift truck.



Alu profile 11/33-156,8mm HD SEALLESS
(art. no. 83.5533)

HD SEALLESS

This profile is a so called dedicate profile. This means this is a profile that has been especially designed for the transport of special (mostly extreme) products. Because of the two protruding round merlons this profile has a very high impact resistance and the special round shape makes it easy to clean. Moist and dusty parts flow back into the so called barrel shape, so moist, mud and dust can simply drain to the outside and will hardly seep through the floor. Because of the low weight a perfect pay load ratio remains. This profile is NOT suitable for the transport of pallets and packaged goods, not even with the help of a fork lift truck!



Alu 10/133mm Leak Proof deckslat HD (Heavy Duty)
(art. no. 89.3497)

LR/LP deckslat

This profile is specially designed for the leak proof and leak resist applications of the Cargo Floor. It fits over a full length solid plastic bearing strip and can't lift away. There remains a channel inbetween the moving slats to make high pressure cleaning possible. The profile can only be combined with a special T-subdeck. The total configuration of the T-subdeck, solid bearing block and this deckslat profile makes the highest resistance against high impact! It is not suitable for carrying fine materials and pallets. Also available in a 7mm. light weight version.

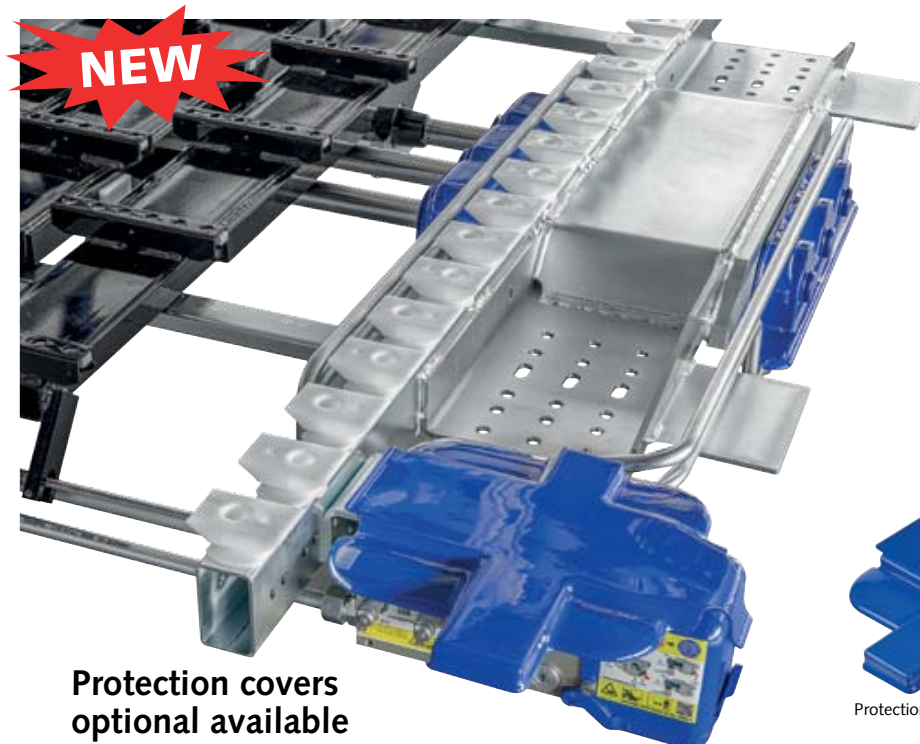

Protection covers optional available



Protection cover cylinder bottom side
art. no. 7371053

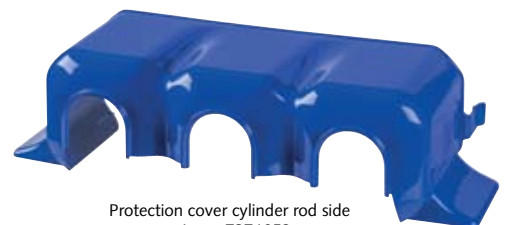

Protection cover cylinder rod side
art. no. 7371052



Protection cover control valve top side
art. no. 7371054



Protection cover control valve rear side
art. no. 7371051
RHD art. no. 7371055

Multi-functionality	Leak resistance	cleanability	Pallet-/bales transport	Drive over with a fork lift truck	Impact resistance	Weight approx.
						X
						X + 310 kg
						X + 710 kg
						X + 730 kg
						not comparable



Subdeck and Guidance

Standard Cargo Floor system

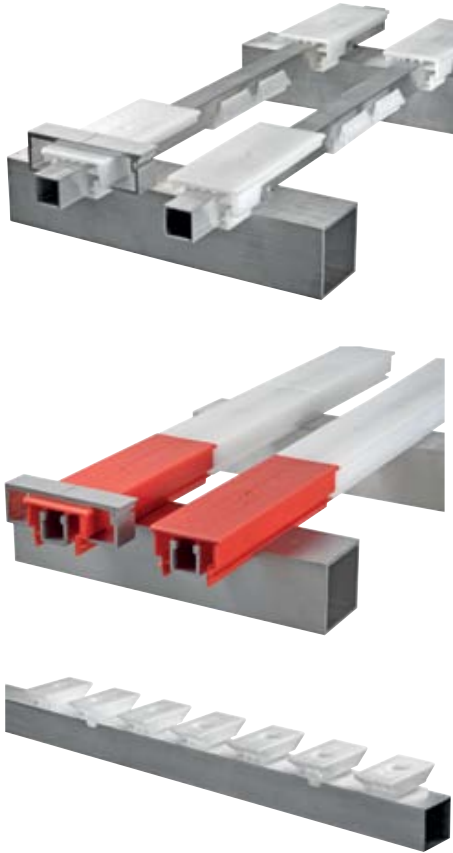

Cargo Bulkmove = 15 Moving floor profiles; only bulk no pallets!

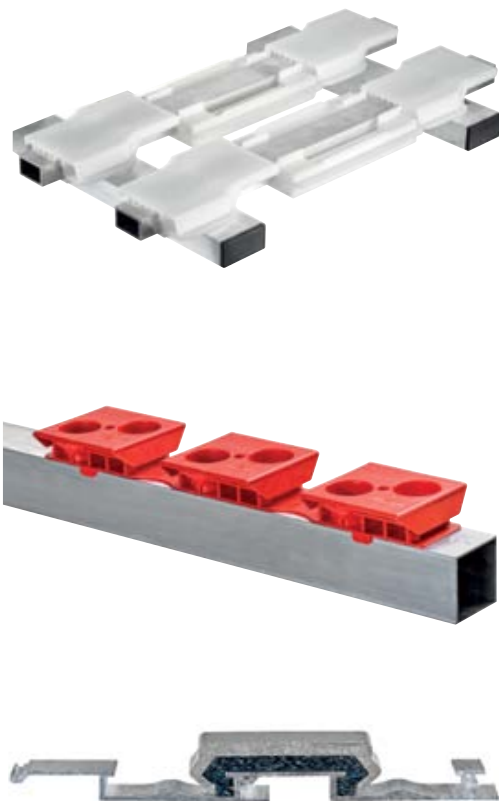



Cargo Roller
art. no. 5165003



Wireless remote control set
"plug & play"
art. no. 6104006



Floor mat for moving headboard
HD extra reinforce rubber
art. no. 4199006



High pressure gauge
art. no. 7199003 rear connector
art. no. 7199002 under connector

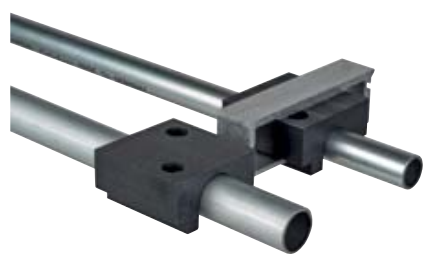

Hydraulic tube bracket and guidance
art. no. 4105009.1 return 1" - 25
art. no. 4105010 pressure 3/4" - 20



First aid tools + parts
Toolbox art. no. 6415105
art. no. 6415106



TECHNICAL SPECS

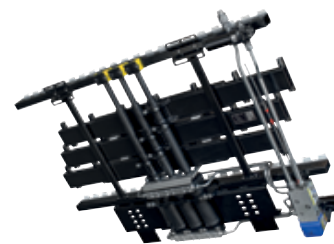
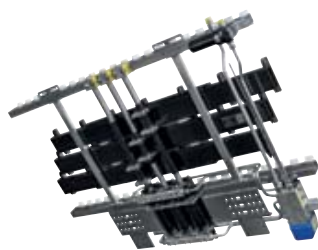

	Type	CF500 SLC-3.9 (Power Speed)*				CF600 HDC-4.7	
		Metric		US/Imperial		Metric	US/Imperial
Weight (from)	kg / lbs	450		992		538	1186
Available in Cargo Bulkmove execution		yes	(yes)*	yes	(yes)*	yes	yes
Operating possibilities		E/B/A	(B/A)*	E/B/A	(B/A)*	E/B/A	E/B/A
Cylinder bore	mm / inch	100		3,9		120	4,7
Piston rod diameter	mm / inch	45		1,8		45	1,8
Working stroke	mm / inch	200		7,9		200	7,9
Cylinder volume	ltr / US gallon	2,82		0,7		4,2	1,1
Oil volume per cycle	ltr / US gallon	8,45		2,2		12,6	3,3
Working pressure	bar / PSI	170		2466		130	1885
Max. pressure	bar / PSI	225		3263		205	2973
Advised oil flow per minute	ltr / US gallon	110	(180)*	29	(48)*	110	29
Max. oil flow per minute	ltr / US gallon	130	(200)*	34	(53)*	190	50
Pressure filter	µm / micron	10	(2x10)*	10	(2x10)*	10	10
Speed at advised oil flow per minute	mtr / ft	2,6	(4)*	8,5	(13,1)*	1,7	5,6
Speed at max oil flow per minute	mtr / ft	3,1	(4,7)*	10,2	(15,4)*	3,0	9,8
Theoretical unloading time trailer 13.6mtr/45 ft	min / min	6	(3)*	6	(3)*	9	9
Max. loading capacity	ton / lbs	40		88185		50	110231
Max. loading capacity	ton / US ton	40		44		50	55
Advised pump capacity (2-line system):							
Flow per minute	ltr / US gallon	110	(180)*	29	(48)*	110	29
Pressure	bar / PSI	250		3626		220	3191
Pressure piping diameter	mm / inch	20x2	(25x2)*	¾x0.08	(1x0.08)*	25x2	1x0.08
Return piping diameter	mm / inch	25x2	(30x2)*	1x0.08	(1¼x0.08)*	25x2	1x0.08
Oil tank filling at advised flow	ltr / US gallon	110	(180)*	29	(48)*	100	26
Oil tank filling at max. flow	ltr / US gallon	130	(200)*	34	(53)*	190	50
Max. oil temperature	°C / °F	70		158		70	158

Oil type: mineral and biological (HEES)

Normal temperature range -15 < 30°C / 5 < 86 °F ISO VG32

Low temperature range -25 < 0°C / -13 < 32 °F ISO VG22

High temperature range 15 < 40°C / 59 < 104 °F ISO VG46

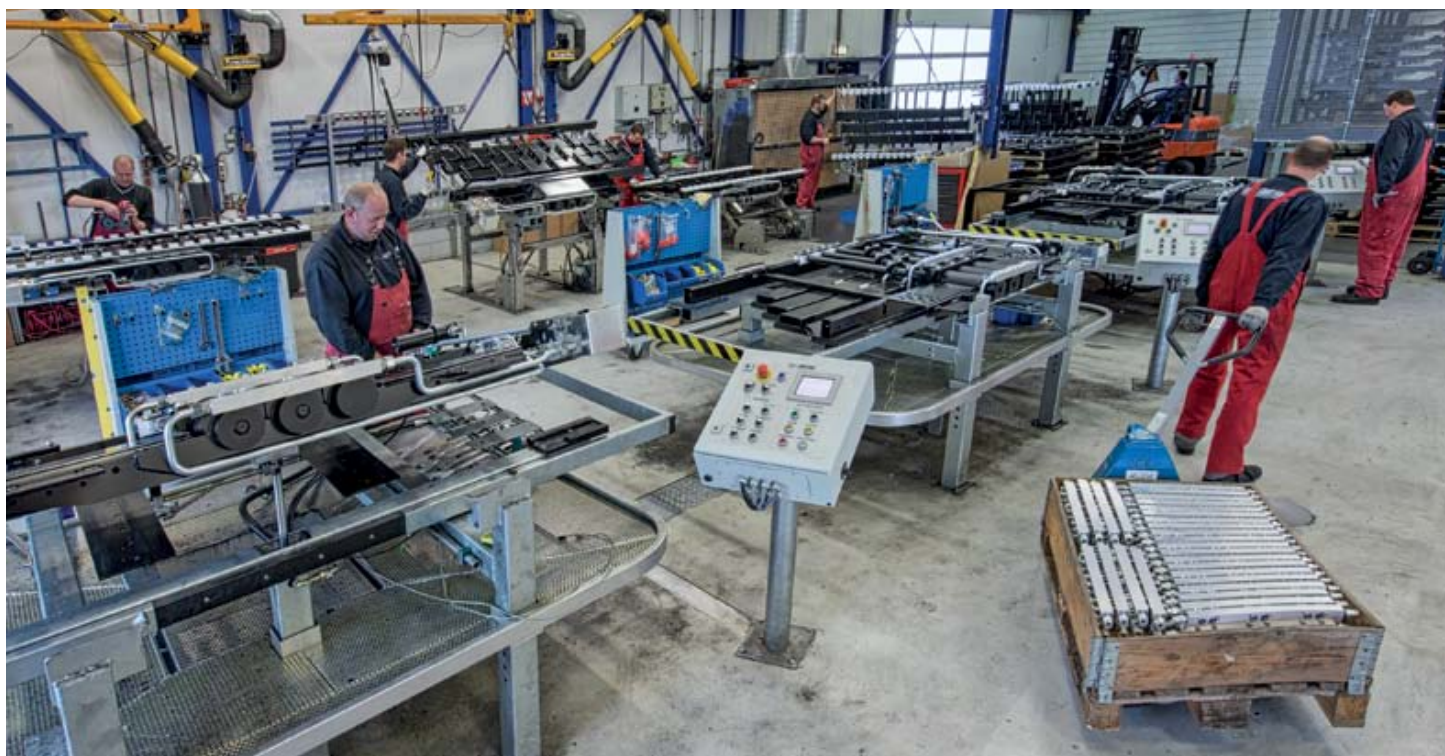

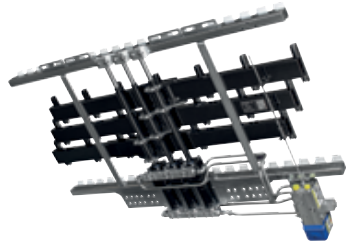

CF100 SLL-3.1

Metric	US/Imperial
295	650
yes	yes
E/B/A	E/B/A



CF3 LP-4.9

Metric	US/Imperial
310	683
yes	yes
E/B/A	E/B/A

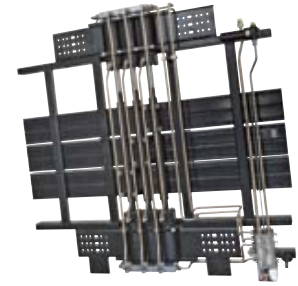

CF800 HD-6 cyl.

Metric	US/Imperial
1038	2288
yes	yes
E/B/A	E/B/A

80	3,1
35	1,4
150	5,9
1,36	0,4
4,09	1,1
130	1885
175	2538
70	18
80	21
10	10
2,6	8,5
2,9	9,5
n.v.t.	n.v.t
20	44092
20	22

125	4,9
60	2,4
150	5,9
3,26	0,9
9,77	2,6
125	1813
150	2176
130	34
170	45
10	10
2,0	6,6
2,6	8,5
7	7
35	77162
35	39

100	3,9
50	2,0
200	7,9
5,5	1,5
16,5	4,4
170	2466
225	3263
110	29
130	34
10	10
1,3	4,3
1,6	5,2
12	12
80	176370
80	88

70	18
200	2901
20x2	¾x0.08"
25x2	1x0.08"

110	29
175	2538
20x2	¾x0.08"
25x2	1x0.08"

110	29
250	3626
20x2	¾x0.08"
25x2	1x0.08"

70	18
80	21
70	158

130	34
170	45
70	158

100	26
130	34
70	158



Inhouse computer animated training

MOVING FLOOR®

The Lightest ..
The Strongest ..
Simply The Best !



Free, mobile App!



CARGO FLOOR®
HORIZONTAL LOADING-/UNLOADINGSYSTEM

Cargo Floor B.V.
Byte 14
7741 MK COEVORDEN
The Netherlands
Telefoon +31 524 593 900

www.cargofloor.com
info@cargofloor.com



**WORLDWIDE
SERVICE NETWORK**